



Emerging
Technologies

Code Enforcement for Commercial Heat Pump Water Heaters

March 2022



Code Enforcement for Commercial Heat Pump Water Heaters

Prepared for

Karen Janowitz, Project Principal Investigator

Washington State University Energy Program on behalf of Bonneville Power Administration

Prepared by

Seth McKinney, Evan Green, and Jon Heller

Ecotope Inc.

The following report was funded by the Bonneville Power Administration (BPA) to assess emerging technology topics that have the potential to increase energy efficiency. BPA is committed to identify, assess and develop emerging technologies with significant potential for contributing to efficient use of electric power resources in the Northwest.

BPA does not endorse specific products or manufacturers. Any mention of a particular product or manufacturer should not be construed as an implied endorsement. The information, statements, representations, graphs and data presented in these reports are provided by BPA as a public service. For more reports and background on BPA's efforts to "fill the pipeline" with emerging, energy-efficient technologies, visit the ET website at www.bpa.gov/goto/e3t.



ABSTRACT

This case study demonstrates that when energy codes require Commercial Heat Pump Water Heaters (CHPWHs) and building codes exist for each system component, standard code enforcement rules smoothly incorporate compliance for CHPWH systems. This finding is relevant for code development in jurisdictions seeking to incorporate CHPWHs into energy code and jurisdictions like Seattle, standardizing CHPWH code enforcement.

This case study describes the process for establishing the code enforcement convention for CHPWHs in Seattle and details the insights regarding energy code adoption of CHPWHs and how reference standards could improve CHPWH adoption and code compliance and enforcement.

Our recommendations include establishing CHPWHs as an optional measure in the International Energy Conservation Code. Additionally, further developing the Advanced Water Heat Specification to incorporate a reference standard, accepted by the International Code Council, would improve the design quality and performance of CHPWH installations.

Table of Contents

- ABSTRACTiii
- Table of Contents..... iv
- Acronyms..... iv
- Introduction..... 1
- Findings..... 1
- Outcomes 3
- Recommendations 4
- Works Cited 4
- APPENDIX A – Code Convention Process..... 5
- APPENDIX B – SDCI Tip 424: Heat Pump Water Heating for Commercial and Multifamily Buildings18
- APPENDIX C – Enforcement Lanes Diagram..... 19
- APPENDIX D – Guidelines 20
- APPENDIX E – Relationship Matrix 21
- APPENDIX F – Stylized CHPWH Sketches..... 22

Acronyms

- CHPWH – Commercial Heat Pump Water Heater
- ICC – International Code Council
- IECC – International Energy Conservation Code
- PH-SKC – Department of Public Health, Seattle-King County
- SDCI – Seattle Department of Construction and Inspection



Introduction

Commercial Heat Pump Water Heater systems comprise novel configurations of standard components: heat pumps, water storage, heat exchangers, and domestic hot water distribution. This case study demonstrates that when energy codes require CHPWHs and building codes exist for each CHPWH system component, standard code enforcement rules can smoothly incorporate compliance for CHPWH systems. This finding is relevant for code development in jurisdictions seeking to incorporate CHPWHs into energy code and in jurisdictions like Seattle seeking to standardize CHPWH code enforcement.

The following describes Seattle's method to incorporate CHPWHs into an informal code enforcement convention, acknowledging CHPWHs as unique configurations of familiar components with enforcement responsibilities across code disciplines. As jurisdictions with multiple code enforcement disciplines and personnel consider incorporating CHPWHs into energy code or observe installations within their enforcement areas, they may benefit from the path Seattle took to identify and define their standards for CHPWH plan review and inspections.

Over two months, our team held four one-hour workshops with training, plus a half-day site tour, and several supplemental conversations with the Seattle Department of Construction and Inspection and the plumbing staff from the Department of Public Health, Seattle-King County – collectively “code staff” – with the goals of:

- Establishing guidelines for CHPWH code enforcement in Seattle
- Understanding the generalizability of CHPWH code compliance to inform code development beyond Seattle
- Exploring the option to streamline CHPWH code compliance and enforcement via the Advanced Water Heating Specification as a reference standard

CHPWHs reduce onsite building emissions, construction costs, and the risk of stranded gas infrastructure assets in both new construction and existing buildings. Establishing CHPWHs in energy code is a critical step for jurisdictions seeking to electrify and decarbonize commercial buildings. This project revealed that building code enforcement is not a barrier to CHPWH adoption in energy code. To that end, our recommendations include establishing CHPWHs as an optional measure in the IECC. Additionally, improving the Northwest Energy Efficiency Alliance’s (NEEA) Advanced Water Heat Specification (AWHS) to incorporate a reference standard accepted by the International Code Council would make the system quality and performance criteria established in the AWHS easily adoptable into municipal or state codes, thereby streamlining code compliance and enforcement.

Findings

As CHPWHs grow in market share, designs and installations interact with diverse building and energy codes across jurisdictions. Some jurisdictions have begun to require CHPWHs in code; Seattle Energy

Code requires CHPWH systems in several commercial and multifamily residential building categories as of January 1, 2022 (see Section C404.2.3 of the Seattle Energy Code). Notably, Seattle established codes on CHPWHs in the energy code only; no other building code contains a reference to CHPWHs.

Four code inspection disciplines participated in this project: energy code, mechanical, and boiler/pressure vessel representing SDCI; plumbing/public health representing PH-SKC. Code staff have clear enforcement lanes; each code discipline enforces its section of code. Enforcement disciplines establish clear boundaries where building systems interact with multiple disciplines. For example, both the SDCI mechanical and PH-SKC plumbing inspect heat pump condensate drainage: mechanical inspects the size and connection of the drainpipe and its routing to a drain; plumbing inspects the drain itself. If the plumbing inspector finds a condensate pipe improperly routed to a drain, the inspector may notify the mechanical inspector and the general contractor on the job site. However, neither the code nor the enforcement process formally requires this communication between disciplines.

Though no formal agreements exist across code disciplines¹, informal professional interactions are essential to ensuring that a code-compliant CHPWH system does not negatively interact with other building systems. Professional aptitude and

knowledge of the relevant codes and reference standards inform how and when disciplines communicate, but no convention exists to define boundaries or communication between disciplines.

This insight helped establish the need to define the relationships between code disciplines and the component configurations that comprise a CHPWH. Simply naming the enforcement boundaries (enforcement lanes) defined each discipline's relationship with the CHPWH components, eliminating the need for a special CHPWH enforcement process in Seattle.

Over two months, the project team collaborated with the code staff to develop a convention that defines the relationship between code staff related to CHPWHs, specifically addressing communication gaps and defining enforcement lanes. This convention is outlined below:

- 1) A **purpose** for establishing a convention for CHPWH code enforcement: *In light of Energy Code requirements and emerging market developments, enable code staff to effectively review and inspect CHPWHs using existing tools, resources, and training.*
- 2) A code **enforcement map** that demonstrates the existing inspection and review processes that define the code enforcement "lanes" and their relationships between codes staff for CHPWHs.

¹ A memorandum of understanding between SDCI and PH-SKC helps to define how these intergovernmental departments interact.

- 3) A set of **guidelines and resources** beginning with a plan set of an existing CHPWH installation that the code staff marked-up together, which informed a set of guidelines, a relationship matrix, and stylized sketches of CHPWH configurations. These further defined the relevant CHPWH components and code enforcement authority for code staff.

The project team used Lean principles to develop the Seattle CHPWH code enforcement convention. The foundational book on Lean: *Lean thinking: Banish waste and create wealth in your corporation* (Womack and James) establishes five Lean principles:

- Value (define the need and purpose)
- Value stream (map the steps to create value and eliminate waste)
- Flow (remove barriers and standardize)
- Pull (define who needs what and when; timing and connection across needs)
- Perfection (continually improve)

Jurisdictions navigating the effects of new code requirements, such as those related to CHPWHs, may choose to adopt a similar convention. A description of our process, including model agendas for each workshop, can be found in Appendix A.

Adherence to AWHS is accepted in Seattle as an exception to satisfy code requirements, though it is not a requirement. Seattle's approach is progressive among jurisdictions; other jurisdictions would be unlikely to adopt AWHS, even as an exception, without ICC certification. Code staff concluded that a requirement to adhere to the AWHS would

- a) help standardize minimum design requirements for CHPWHs, improving the consistency and operability of systems, and b) streamline aspects of code enforcement, especially in modularized or skid-mounted CHPWHs.

An AWHS appendix that serves as an ICC-accepted reference standard would remove a primary barrier to broad AWHS adoption in code.

Outcomes

This engagement's primary goal was to understand CHPWH code enforcement and develop a CHPWH code enforcement convention in Seattle. In developing the convention, the project team gained an understanding of the experience of CHPWHs by code professionals and the associated code enforcement challenges. With this understanding, the project team helped streamline code enforcement using existing expertise without additional code language or a new enforcement process. And, SDCI and PH-SKC have used the CHPWH code convention to clarify the existing MOU between the intergovernmental departments regarding CHPWH code enforcement. Furthermore, the following observations emerged:

- Building code enforcement is not a barrier to CHPWH adoption in energy code, further opening CHPWHs as a critical component to fully electrifying commercial building loads.
- Training was a critical first step in creating a foundation of knowledge and understanding for SDCI and PH-SKC code staff. Code staff gained an

understanding of how CHPWH components fit into existing enforcement and plan review tools and processes.

- Establishing an ICC accepted standard as part of the AWHs would improve the consistency and operability of CHPWH designs and streamline aspects of code enforcement.

Recommendations

Initiate incorporating International Code Council accepted reference standards into AWHs appendices. Incorporating an ICC accepted reference standard into an AWHs appendix would establish this tool as an authoritative resource to be referenced in code: "a published technical document that represents a stakeholder consensus on how a material, product or assembly is to be designed, manufactured, tested or installed so that a specific level of performance is achieved" (International Code Council Industry Advisory Committee). In addition, CHPWH reference standards could codify quality and performance criteria for CHPWHs as enforceable in code, improving design and streamlining code compliance and enforcement.

Take steps to initiate the adoption of CHPWHs as an optional measure in the International Energy Conservation Code. Leverage an ICC accepted AWHs to incorporate CHPWHs into energy code in order to realize more fully electric buildings. This practical step would increase CHPWH adoption, a viable path for jurisdictions to reduce onsite commercial building emissions. Authorizing CHPWHs as an IECC

optional measure is the first step to establishing this critical path.

Distribute CHPWH training widely. D+R Learn, Ecotope's educational partner, has created modules on CHPWH basics, design, engineering, and code compliance and enforcement. D+R Learn adapted portions of the code convention process described here, conducted additional interviews, and expanded existing tools and modules to create code enforcement training. This training can support CHPWH adoption in energy code and clarify to code developers and enforcers that building code enforcement is not a barrier to CHPWH adoption in energy code. For examples, see Heat Pump Water Heating training from Seattle City Light (June 2021 and November 2021):

<https://www.lightingdesignlab.com/course-recordings-and-handouts>

Works Cited

ICC Reference Standards Guide. International Code Council. October 19, 2020. https://www.iccsafe.org/wp-content/uploads/IAC_Ref-Stds-Guide_10_19_20.pdf

Womack, J. P., & Jones, D. T. (2003). Lean thinking: Banish waste and create wealth in your corporation. New York: Free Press

Tips. Seattle Department of Construction and Inspection. Retrieved September 2021. <https://web6.seattle.gov/DPD/CAMS/camlist.aspx>.



APPENDIX A – Code Convention Process

This appendix provides a description of the project team’s high-level process to arrive at the HPWH code convention, followed by model agendas for each workshop.

1) Defining Need / Purpose

Stakeholder engagement and recruitment.

The workshops benefited from senior code staff participation. Executive engagement was crucial to their recruitment; executive and director-level staff endorsed and attended each workshop.

Pre-workshop survey. A short pre-workshop survey helped the project team learn each participant’s areas of expertise and their initial questions, concerns, and assumptions for how each department and role would be involved in CHPWH code enforcement. The survey also offered an opportunity for participants to express what they wanted; how they would prefer to inspect and coordinate to enforce their code discipline.

Training. Initial high-level training on the “What, How, and Why of Commercial Heat Pump Water Heaters” established a baseline understanding of the CHPWH components and standard configurations. This essential step helped create a foundation of knowledge and understanding for code staff to develop the questions required to establish the code enforcement convention. Recording and distributing this training also allowed other code staff to participate more fully in later sessions.

2) Map the Value

Code Compliance Assistance. SDCI has developed a library of code compliance Tips “designed to provide user-friendly information on the range of City permitting, land use, and code compliance policies and procedures...” (Seattle Department of Construction and Inspection). Because Tips offer summary code compliance requirements, they are ideal for informing emerging code enforcement requirements. The project team provided a technical review and suggested edits for the draft Tip for CHPWHs, which became instrumental for determining the categories and code enforcement lanes and guidelines. Appendix B – Tip to be published to coincide with SDCI’s final draft.

Diagram Enforcement Lanes. The code staff observed a CHPWH in the field at Jackson Apartments in Seattle, generating an initial list of code enforcement assumptions that were clarified during the second and third workshops and in supplemental conversations with code staff. The project team utilized an existing CHPWH plan set, previously submitted for code review to SDCI, which matched the installation visited on the site tour. The code staff marked up the code enforcement boundaries on the plan set during the second and third workshops and subsequent one-on-one conversations. The deep bench of code expertise helped the project team define each code discipline’s enforcement criteria and describe how those criteria define their enforcement “lanes” – the relationships between disciplines. See Appendix C.

3) Create Flow

Guidelines. In collaboration with code staff, we adapted the CHPWH code compliance Tip to develop a set of guidelines that confirm how each CHPWH component complies, categorized by each discipline. See Appendix D.

Reference Standards. Because Seattle (nor any other jurisdiction) uses AWHs as the basis for CHPWHs in code, the code staff discussed the option of using AWHs as a reference standard to streamline code enforcement and compliance. Seattle Energy Code references the AWHs to allow CHPWHs designed to its criteria to qualify as an alternative path to energy code compliance. However, AWHs does not meet the ICC criteria as a reference standard in code. Establishing ICC reference standards could streamline code adoption and compliance for certain aspects of a CHPWH installation and standardize the universe of design configurations.

4) Timing and connection

Relationship matrix. The project team developed a relationship matrix to illustrate the informal connections between enforcement disciplines. The matrix mapped CHPWH component categories along the horizontal axis, the four code enforcement disciplines along the vertical axis, and the code enforcement responsibility for each component in the field of cells. Where multiple responsibilities occur in a single row, a relationship exists between code enforcement disciplines. See Appendix E.

Stylized sketches. The project team adapted a series of stylized configurations to

demonstrate the various configurations and the corresponding alterations to code enforcement. See Appendix F.

5) Continuous improvement

Test and adjust. The project team developed each resource – the *Enforcement Lane Diagram, Guidelines, Relationship matrix, and Stylized sketches* – in collaboration with code enforcement staff. The workshops were working sessions supported by one-on-one conversations with code enforcement and plan review experts and executives from SDCI and PH-SKC. These resources have been delivered to the code staff to use and improve as new scenarios emerge.

Meeting Title: Workshop 1: Support for Seattle DCI on CHPWH Systems

Date: August 18, 2021

Time: 8:30 – 9:30 PDT

Purpose: The **purpose** of this call series is to gain a working understanding of commercial heat pump water heaters and together describe the components of code inspection and plan review for these systems in the City of Seattle.

This first session will provide you with a straightforward overview of the building blocks of commercial heat pump water heater systems. Over our next few meetings, we'll build from this session and our tour on Thursday 8/19 to co-create a process for plans review and field inspection of commercial heat pump water heaters.

Timing / Facilitator	Agenda Item	Goal	Structured Invitation, Organizing Question(s) + Key Content	Copy/paste
8:45-9:00	<i>Welcome and setup</i>	<i>We are all having a similar zoom experience. Allow folks to join late.</i>	<i>Creating a warm welcome & a container for our time together</i> <i>Small talk! Prep and check tech. Start once every org. represented, or 9:02.</i>	<i>Make Seth host, Evan co-host. Evan to share screen.</i> <i>Zoom meeting info:</i> <ul style="list-style-type: none">✓ Gallery view✓ Screen name+ pronouns+ location✓ Mute



<p>9:00-9:02</p>	<p><i>Logistics and parameters</i></p>	<p>We all know how we will operate over the next 60 mins + Get started with a clear purpose. What we will do today.</p>	<p><i>Logistical considerations and guidelines for engagement</i></p>	<p>The PURPOSE of this call series is to gain a working understanding of commercial heat pump water heaters and together describe the components of code inspection and plan review for these systems in the City of Seattle.</p> <p>The objectives for today are to:</p> <ul style="list-style-type: none"> ▶ Describe the essential components of a commercial heat pump water heater (C-HPWH) system ▶ Compare C-HPWH with familiar analogs ▶ Begin developing the key questions needed to review plans and inspect installations for C-HPWHs <p>Roles in Today’s Call:</p> <ul style="list-style-type: none"> ▲ Host: Seth McKinney 🔧 Technical SME: Evan Green
<p>9:02-9:07</p>	<p>Move from familiar to unfamiliar</p>	<p>Connect immediately about the topic at hand</p>	<p>Mentimeter:</p>	<p>What are you most looking forward to achieve in these sessions?</p> <p>What are you most concerned we might not achieve?</p> <p>What burning questions do you have that you would like us to address in the next session?</p>
<p>9:07-9:55</p>	<p>Configuration Overview</p>	<p>Knowledge Transfer</p>	<p>Evan – Presentation</p>	<p>Record</p>



9:55-10:00	Review + Next Steps			Survey – including what they would like to focus on next.
-------------------	---------------------	--	--	---



Meeting Title: Workshop 2: Support for Seattle DCI on CHPWH Systems

Date: September 1, 2021

Time: 8:30 – 9:30 PDT

Purpose: The **purpose** of this call series is to gain a working understanding of commercial heat pump water heaters and together describe the components of code inspection and plan review for these systems in the City of Seattle.

In session 2, we will focus and document the key questions that must be answered and prerequisites for a minimum viable CHPWH plans review and inspection process.

Timing / Facilitator	Agenda Item	Goal	Structured Invitation, Organizing Question(s) + Key Content	Copy/paste
8:45-9:00	Welcome and setup	We are all having a similar zoom experience. Allow folks to join late.	<p>Creating a warm welcome & a container for our time together</p> <p>Small talk! Prep and check tech. Start once every org. represented, or 9:02.</p>	<p>Make Seth host, Evan co-host. Evan to share screen.</p> <p>Zoom meeting info:</p> <ul style="list-style-type: none"> ✓ Gallery view ✓ Screen name+ pronouns + location ✓ Mute
9:00-9:05	Logistics and parameters	We all know how we will operate over the next 60 mins + Get started with a clear purpose. What we will do today.	Logistical considerations and guidelines for engagement	<p>The PURPOSE of this call series is to gain a working understanding of commercial heat pump water heaters and together describe the plan review and code inspection workflow for these systems.</p> <p>The objectives for today are to:</p> <ul style="list-style-type: none"> ➤ Discussion about final deliverables and processes ➤ Review and finalize draft processes/checklists



				<p>► Collect feedback on the draft Tip</p> <p>Roles in Today’s Call:</p> <p>▲ Host: Seth McKinney</p> <p>🔗 Technical SME: Evan Green</p> <p>◆ Resources ◆</p> <p>https://neea.org/img/documents/Advanced-Water-Heating-Specification.pdf</p>
9:05-9:50	Plan set review	<p>► Review the inspection team mark up on the Jackson apartment plan sets</p> <p>► Determine overlap/duplication, if any</p> <p>► Discover gaps in the workflow, if any</p>	<p>Direct toward minimum useful workflow.</p> <p>Elaborate to establish full scope of each step in the process.</p> <p>Fill-in code gaps, where possible – request outside of WS.</p> <p>Introduce AWHs as potential reference standard</p>	

	Next Steps	Tip Document	Create viable Tip for today; consider how AWHs could inform a more user-friendly tip document, and/or director's rule, and/or future code	
--	------------	--------------	---	--



Meeting Title: Workshop 3: Support for Seattle DCI on CHPWH Systems

Date: September 15, 2021

Time: 8:30 – 9:30 PDT

Purpose: The **purpose** of this call series is to gain a working understanding of commercial heat pump water heaters and together describe the components of code inspection and plan review for these systems in the City of Seattle.

In Session 3 we will collect and discuss feedback on the draft inspection/plans review process and brainstorm real world scenarios to refine.

Timing / Facilitator	Agenda Item	Goal	Structured Invitation, Organizing Question(s) + Key Content	Copy/paste
8:45-9:00	Welcome and setup	We are all having a similar zoom experience. Allow folks to join late.	Creating a warm welcome & a container for our time together Small talk! Prep and check tech. Start once every org. represented, or 9:02.	Make Seth host, Evan co-host. Evan to share screen. Zoom meeting info: <ul style="list-style-type: none"> ✓ Gallery view ✓ Screen name+ pronouns + location ✓ Mute
9:00-9:05	Logistics and parameters	We all know how we will operate over the next 60 mins + Get started with a clear purpose. What we will do today.	Logistical considerations and guidelines for engagement	The PURPOSE of this call series is to gain a working understanding of commercial heat pump water heaters and together describe the plan review and code inspection workflow for these systems. The objectives for today are to: <ul style="list-style-type: none"> ➤ Discussion about final deliverables and processes ➤ Review and finalize draft processes/checklists



				<p>► Collect feedback on the draft Tip</p> <p>Roles in Today's Call:</p> <p>▲ Host: Seth McKinney</p> <p>🔗 Technical SME: Evan Green</p> <p>◆ Resources ◆</p> <p>https://neea.org/img/documents/Advanced-Water-Heating-Specification.pdf</p>
9:05-9:15	Decision process	Define decision process / make decision	How are new processes and agreements established at SDCI and between SDCI and PH-SCK?	
9:15-9:30	Review / Finalize Drafts		<ul style="list-style-type: none"> • Get input on plan • Review division of labor • Point person formerly identified at SDCI who can be referred to for inquiries from industry partners regarding equipment/device and/or design configuration 	

			compliance to Energy Code?	
	Collect feedback on the draft Tip	Tip Document	Create viable Tip for today; consider how AWHs could inform a more user-friendly tip document, and/or director's rule, and/or future code	Do inspections together
	Next steps	What? So what? Now What? How will we improve?	Plans to test and improve the process	
	Celebrate	Review Ecosizer	Familiarize with Ecosizer	



Meeting Title: Workshop 4: Support for Seattle DCI on CHPWH Systems

Date: September 22, 2021

Time: 8:30 – 9:30 PDT

Purpose: The **purpose** of this call series is to gain a working understanding of commercial heat pump water heaters and together describe the components of code inspection and plan review for these systems in the City of Seattle.

In session 4, we will review and finalize draft processes/checklists. We will also collect feedback on the draft Tip, go over next steps, create plans to test and improve the process, and celebrate!

Timing / Facilitator	Agenda Item	Goal	Structured Invitation, Organizing Question(s) + Key Content	Copy/paste
8:45-9:00	Welcome and setup	We are all having a similar zoom experience. Allow folks to join late.	Creating a warm welcome & a container for our time together Small talk! Prep and check tech. Start once every org. represented, or 9:02.	Make Seth host, Evan co-host. Evan to share screen. Zoom meeting info: <ul style="list-style-type: none"> ✓ Gallery view ✓ Screen name+ pronouns+ location ✓ Mute
9:00-9:05				
9:05-9:50	Review Deliverables	Review deliverables, show final drafts and early drafts of diagrams. Collect Feedback.	Make ourselves available to update. Also offer the engineering deep dive trainings.	https://www.lightingdesignlab.com/education



9:50-10:00	Celebrate!	Next Steps	Determine how we continue to communicate after we wrap up and deliver materials.	
-------------------	------------	------------	--	--



APPENDIX B – SDCI Tip 424: Heat Pump Water Heating for Commercial and Multifamily Buildings

Seattle Department of Construction
and Inspections

Tip 424

Seattle Permits

— part of a multi-departmental City of Seattle series on getting a permit

Heat Pump Water Heating for Commercial and Multifamily Buildings

November 10, 2021

Commercial heat pumps can produce domestic hot water using about a third of the energy of conventional gas and electric boilers. Heat pump water heaters (HPWHs) using CO₂ refrigerant can even deliver hot water well below freezing temperatures. Heat pumps extract heat from the air (even cold air) and transfer that heat into the incoming cold water. Seattle requires heat pump water heating for most new buildings and new “central water heating” equipment in existing hotel and multifamily buildings. Central water heating refers to water heating systems that serve multiple dwelling or sleeping units, a circulating hot water system, or a hot water system that serves numerous building areas.

Where Required

You must provide heat pump water heating (HPWH) for the following building categories if you apply for a permit after January 1, 2022. (See Section C404.2.3 of the Seattle Energy Code for the complete scope.) A general summary of those categories includes:

- **Multifamily buildings four stories or taller with central water heating systems:** new construction, substantial alterations, and equipment replacement.
- **Hotels/motels:** new construction, substantial alterations, and equipment replacement.
- **Other commercial buildings:** As of October 2021, the Seattle City Council is considering an amendment that would extend the HPWH requirements to include most commercial buildings, with exceptions for smaller systems. If such an amendment is approved, an effective date would be set for some time in spring of 2022.

This Tip concerns “commercial buildings.” Single-family houses, two-family houses, townhouses, and 1-3 story multifamily buildings are considered “residential buildings” and do not have to comply with these HPWH code requirements.

Permits Required

Obtain all applicable permits for your HPWH system in the City of Seattle, including:

- Plumbing permit from Public Health Seattle King County (PHSKC), which covers:
 - Piping connecting the HPWH equipment, storage tanks, and the distribution system
 - Piping insulation
 - Circulating pumps, valves, strainers, mixing valves, and other components of the hot water distribution system
 - Condensate drainage
- Mechanical permit (can be part of construction permit), which covers:
 - The heat pump equipment itself, including sizing calculations
 - Fans and ductwork for indoor air-source heat pumps
 - Noise regulations
 - Structural support for tanks and equipment (unless slab on grade)
 - Land use regulations on equipment height and location
- Boiler permit, which covers:
 - Hot water storage tanks larger than 37.5 gallons (11.25 gallons in A, E, or I occupancies)
 - Tank insulation
 - Seismic bracing
 - Note that each storage tank requires a separate boiler permit

www.seattle.gov/sdci



Seattle Department of
Construction & Inspections

700 5th Avenue, Suite 2000
P.O. Box 34019
Seattle, WA 98124-0019
(206) 684-8600

Printed on totally chlorine free paper made with 100% post-consumer fiber

APPENDIX C – Enforcement Lanes Diagram

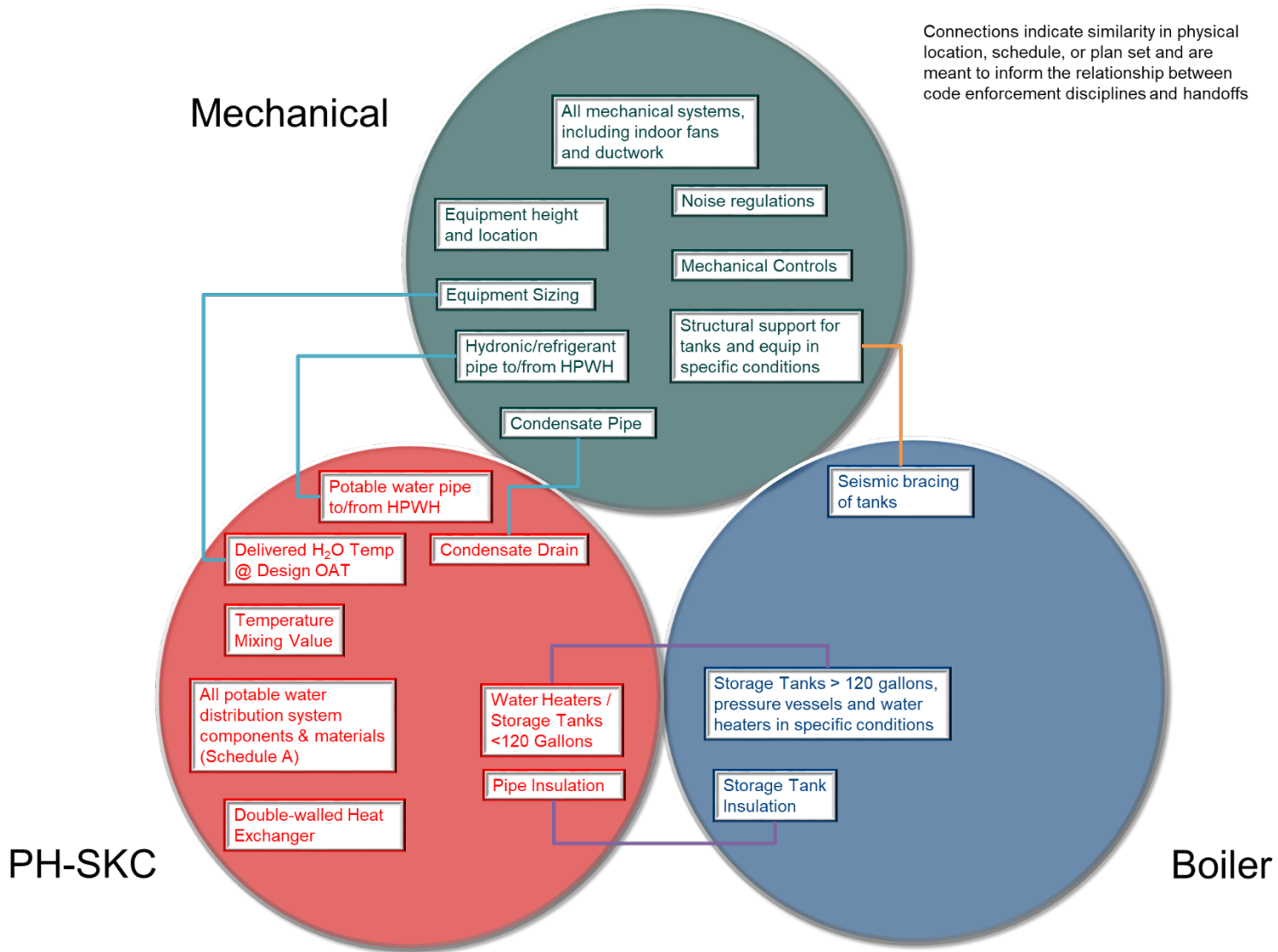

Connections indicate similarity in physical location, schedule, or plan set and are meant to inform the relationship between code enforcement disciplines and handoffs

APPENDIX D – Guidelines

- Plan review (Energy Code or otherwise)
 - **SDCI Mechanical** –
 - Heat pump capacity sizing
 - Tank storage capacity
 - Supplemental electric resistance water heating
 - **PH-SKC** – Gallons per hour at assumed OAT
 - **SDCI Mechanical** – Commissioning
 - **SDCI Mechanical** – Metering
 - **SDCI Boiler** –
 - Pressure vessel insulation (covered under current MOU)
 - Found on mechanical/boiler plan set
 - **PH-SKC** – non-pressure vessel review
 - **SDCI Mechanical** (hydronic/refrigerant piping) and **PH-SKC** (potable water piping) jurisdiction overlaps at the heat exchanger, whether the heat exchanger resides in the heat pump or the tank
- Plumbing permit/inspection from Public Health Seattle King County (PHSKC), which covers:
 - Pipes connecting the HPWH equipment, storage tanks, and the distribution system
 - Pipe insulation
 - Circulating pumps, valves, strainers, mixing valves, delivered water temperature, and other components/materials of the hot water distribution system
- Condensate drainage and relief valve termination point(s)
- Materials – Schedule A minimum requirements
 - Provide minimum materials requirements in Schedule A
 - Website – Plan review, schedule A
- Mechanical permit/inspection from SDCI, which covers:
 - The heat pump equipment itself, including sizing calculations
 - Fans and ductwork for indoor air-source heat pumps
 - Interaction effects with building/garage exhaust systems (where relevant)
 - Non-potable hydronic heat pipping
 - Condensate pipe sizing and routing
 - Noise regulations
 - Structural support for tanks and equipment (unless slab on grade)
 - Land use regulations on equipment height and location
- Boiler permit/inspection from SDCI, which covers:
 - Hot water storage tanks larger than 37.5 gallons (11.25 gallons in A, E or I occupancies) – including expansion tanks
 - Refrigerant vessels larger than 37.5 gallons – currently no products, and unlikely
 - Water heaters exceeding 200k BTUH, 120gal, 160psi, or 210F
 - Tank insulation
 - Seismic bracing

APPENDIX E – Relationship Matrix

	PH-SKC (Plumbing)	Mechanical	Boiler	Energy Code Plan Review
Water Distribution System	<ul style="list-style-type: none"> - Piping that connects HPWH equipment - Hot water distribution system. - Circulating pumps, valves, strainers, mixing valves - Delivered water temperature - Gallons per hour at assumed OAT - Other components/materials of the hot water distribution system. 	<ul style="list-style-type: none"> - Non-potable hydronic heat piping (if any - this is uncommon) 		<ul style="list-style-type: none"> - SDCI - Mechanical
Insulation	<ul style="list-style-type: none"> - Pipe Insulation 		<ul style="list-style-type: none"> - Tank Insulation 	<ul style="list-style-type: none"> - PH-SKC
Condensate	<ul style="list-style-type: none"> - Routing, drainage, relief valve termination point(s) 	<ul style="list-style-type: none"> - Pipe size, connection, routing 		
Heat Pumps		<ul style="list-style-type: none"> - The heat pump equipment itself, including verifying sizing calculations 		<ul style="list-style-type: none"> - SDCI - Mechanical
Electric boilers used as storage tanks and/or as back-up/supplemental heat source	<ul style="list-style-type: none"> - Storage tanks, temperature 		<ul style="list-style-type: none"> - Boilers exceeding 200k BTUH, 120gal, 160psig, or 210F 	<ul style="list-style-type: none"> - SDCI - Mechanical / PH-SKC
Fans/Ductwork		All		<ul style="list-style-type: none"> - SDCI - Mechanical
Exhaust		All		<ul style="list-style-type: none"> - SDCI - Mechanical
Noise		All		
Structural		<ul style="list-style-type: none"> - Structural support for tanks and equipment over 400# (unless slab on grade) 	<ul style="list-style-type: none"> - Seismic Bracing of Tanks 	
Location		All		
Vessels	<ul style="list-style-type: none"> - Storage tanks, temperature 		<ul style="list-style-type: none"> - Hot water storage tanks larger than 5 cu.ft. (37.5 gallons) or 1.5 cu.ft. (11.22 gallons) for A, E or I occupancies. Includes expansion tanks and refrigerant vessels. 	<ul style="list-style-type: none"> - SDCI - Boiler



APPENDIX F – Stylized CHPWH Sketches

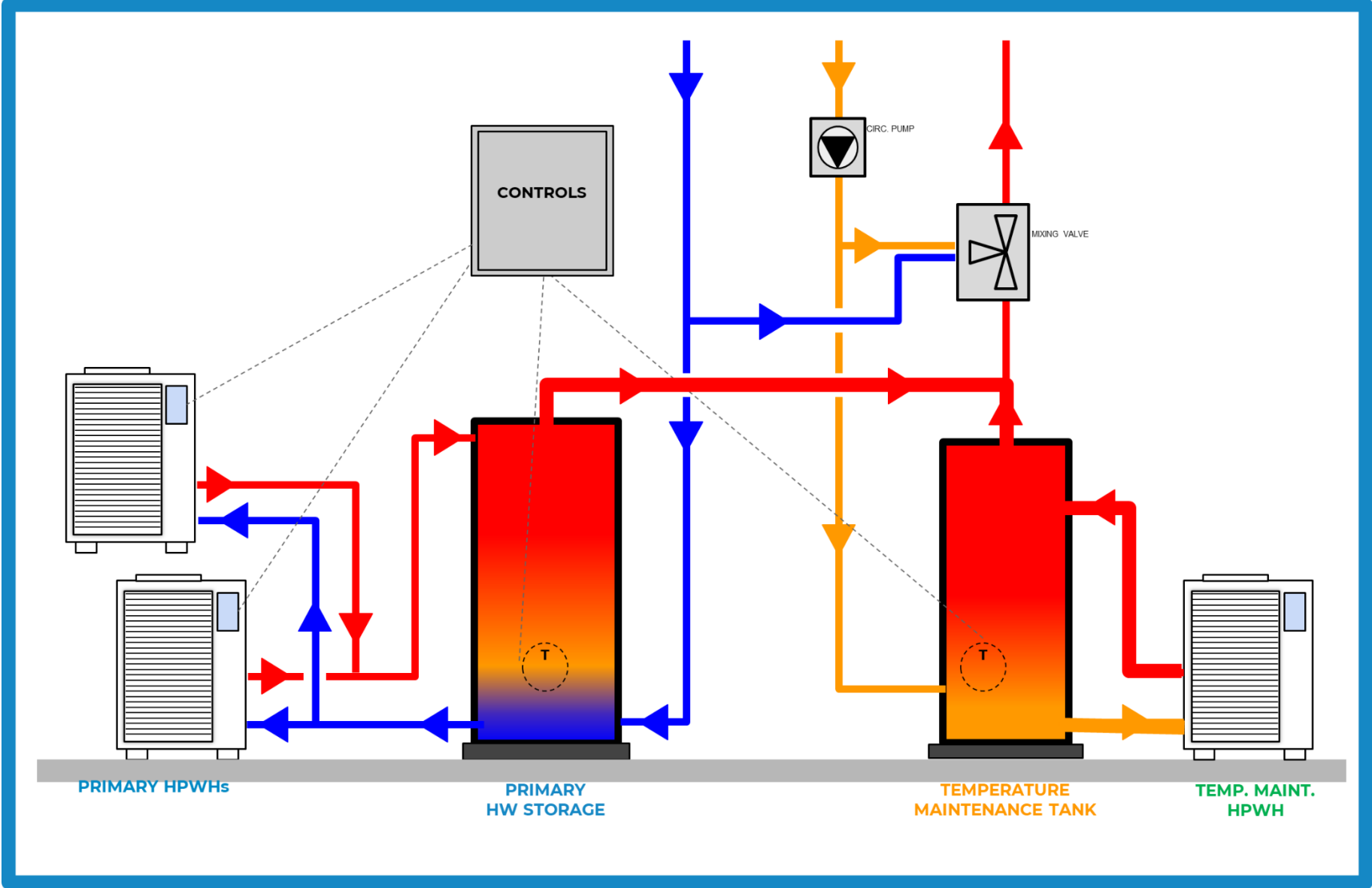

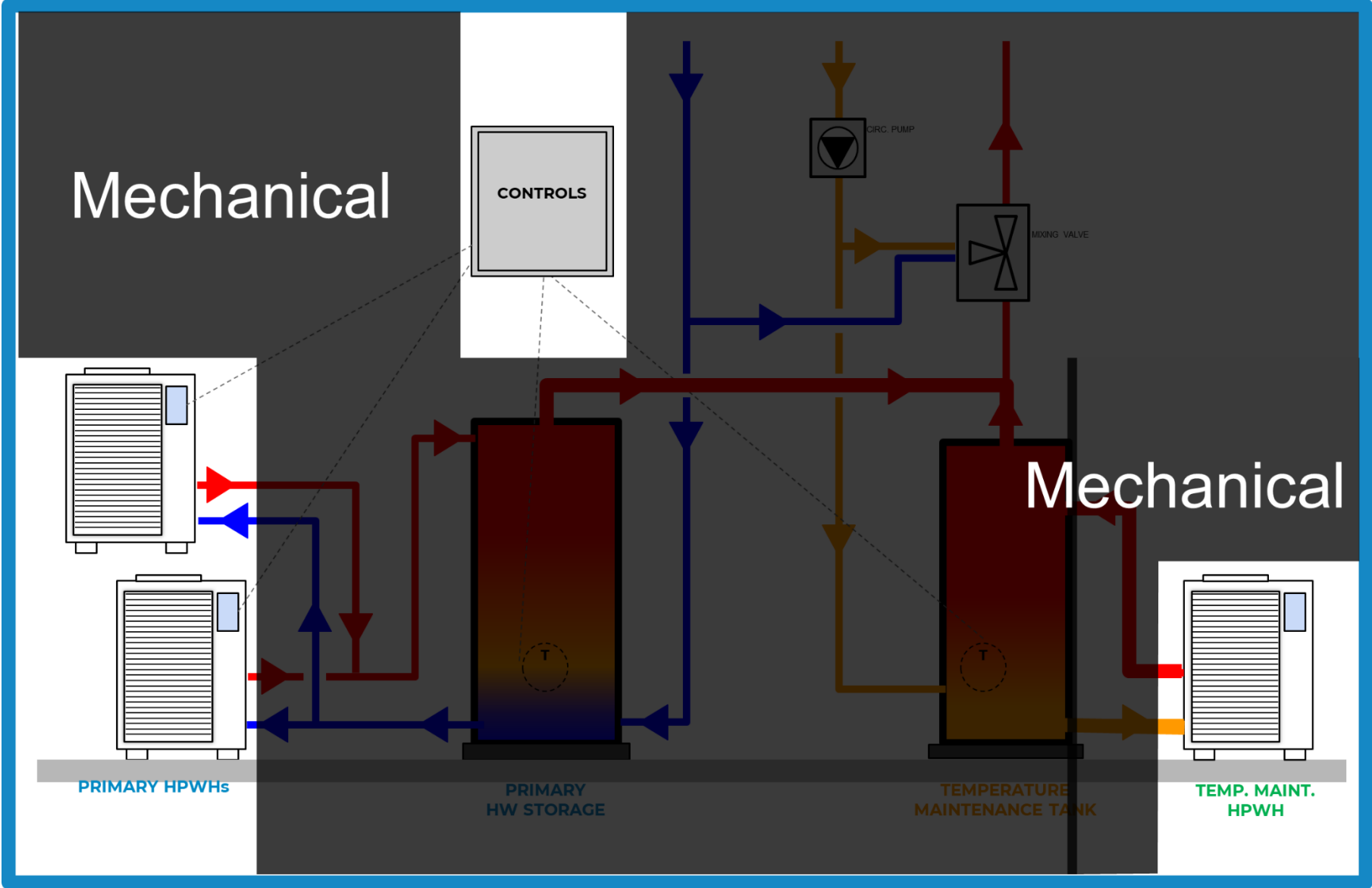

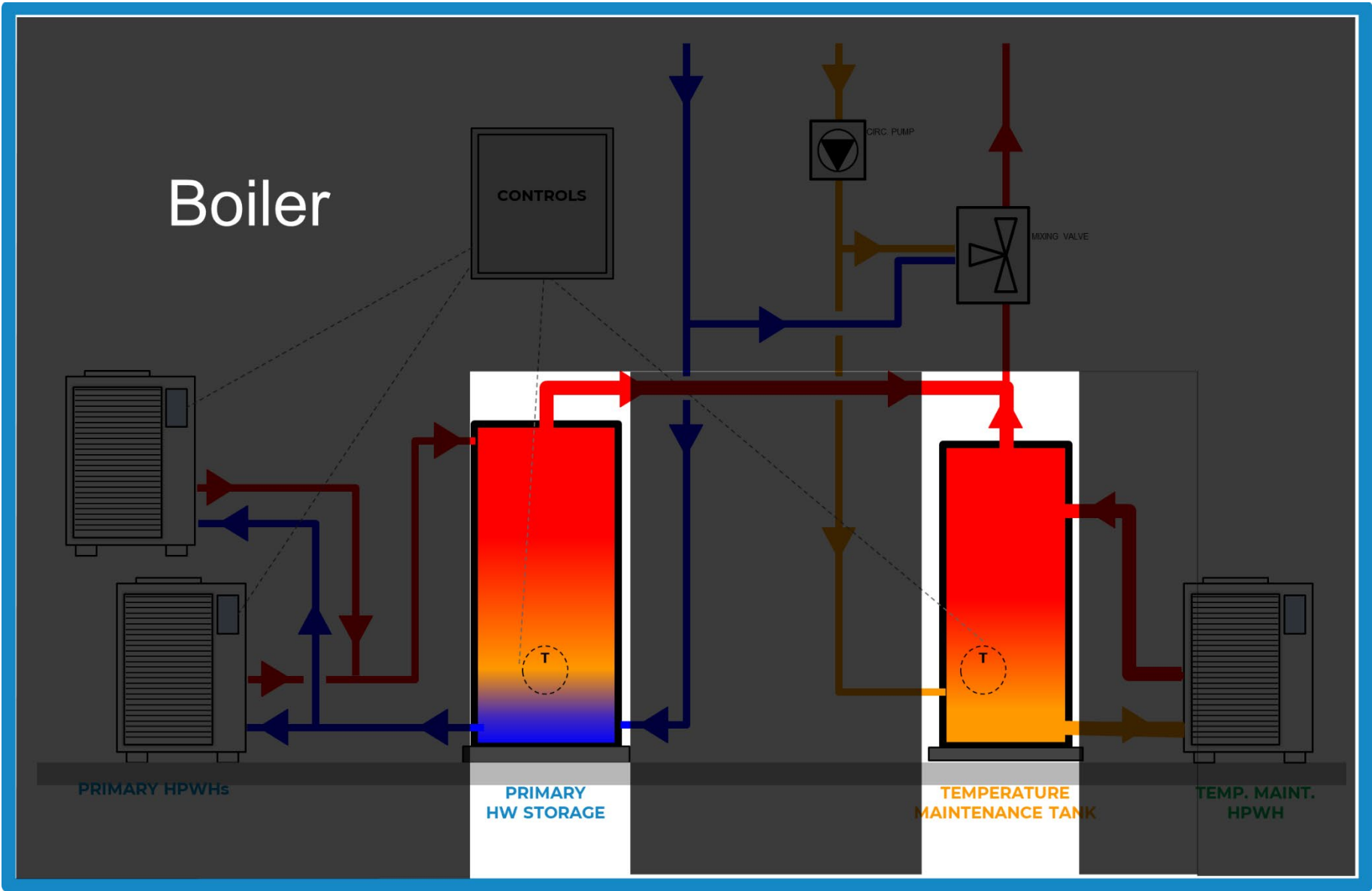

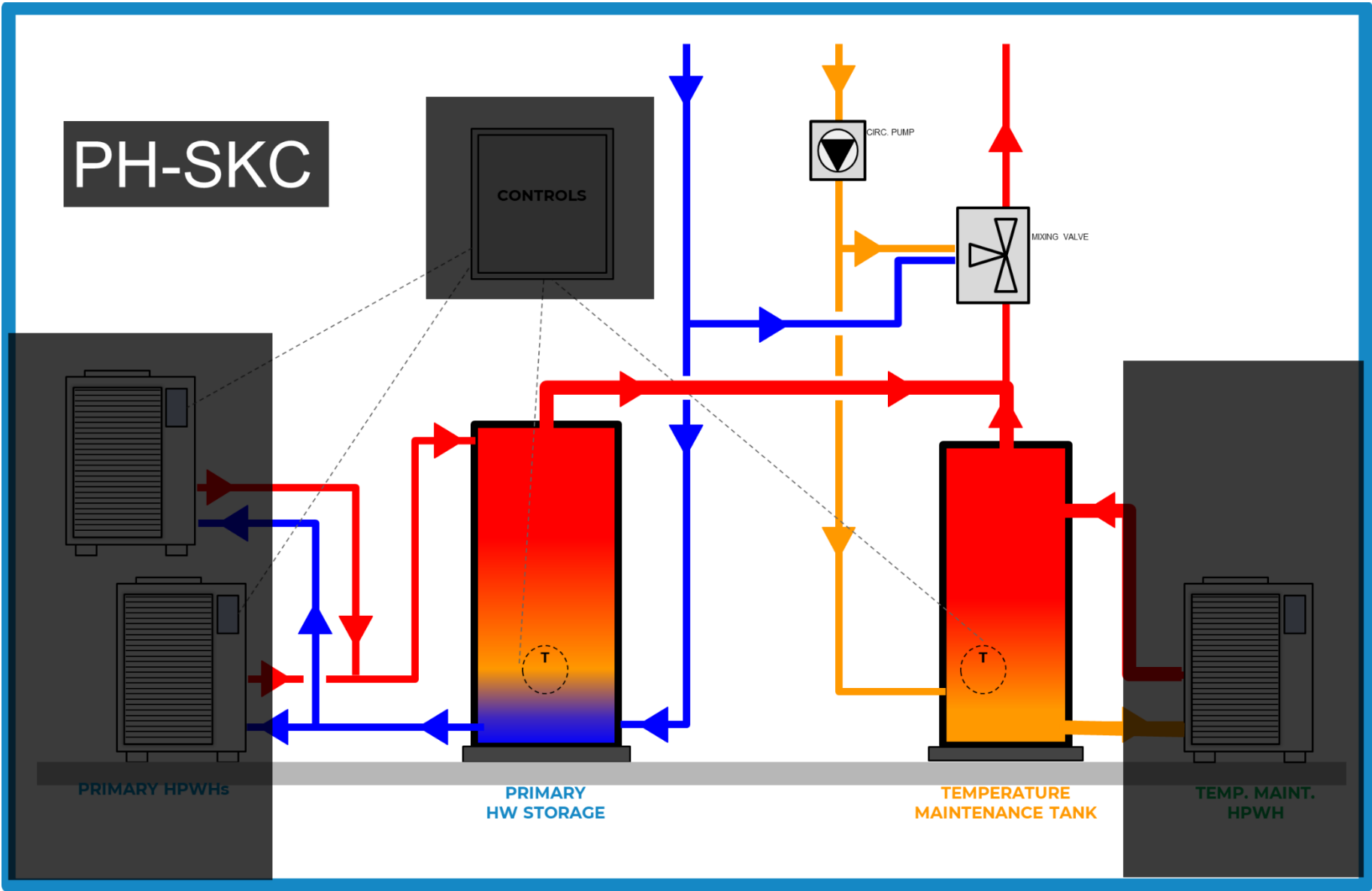

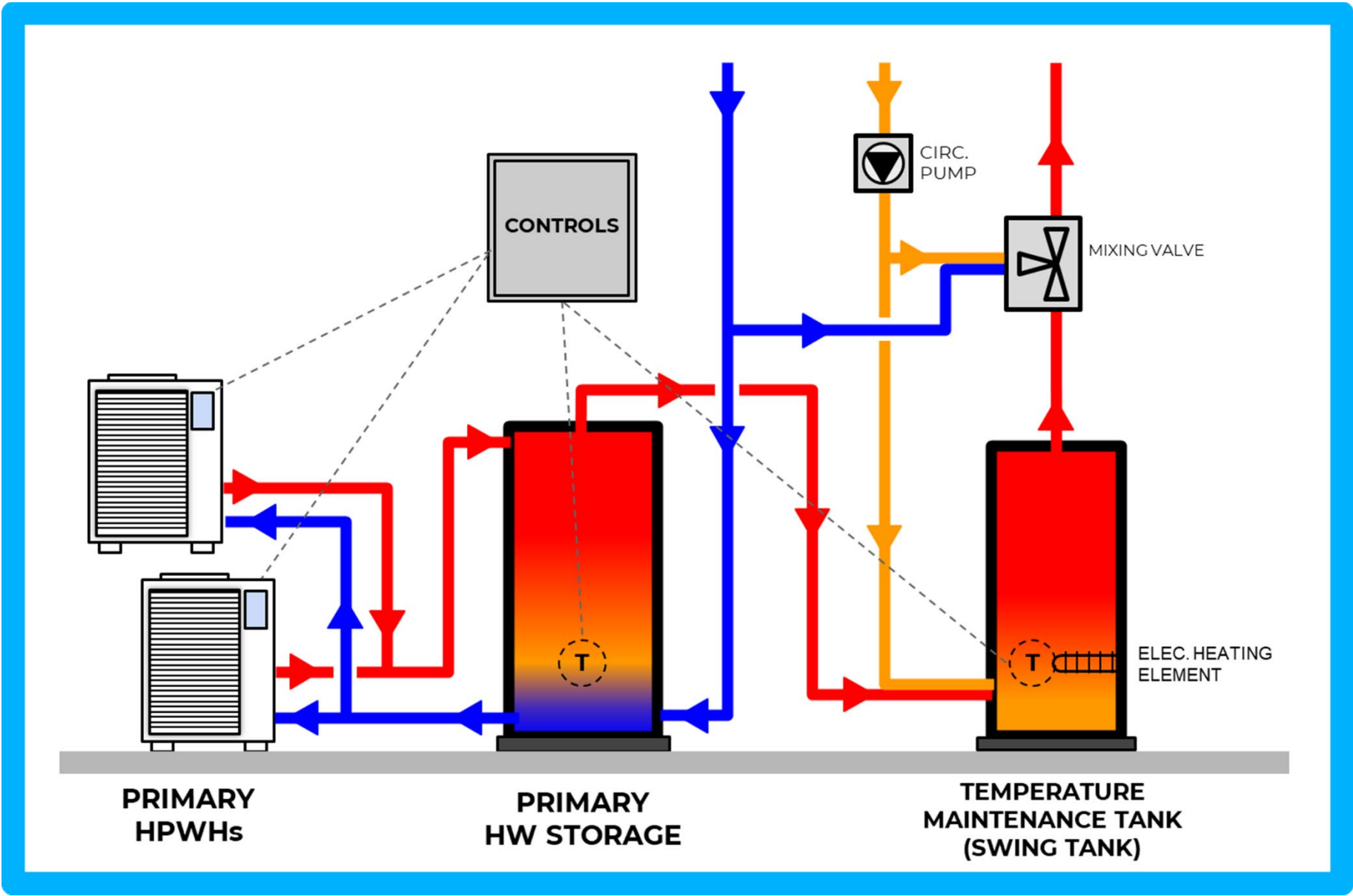

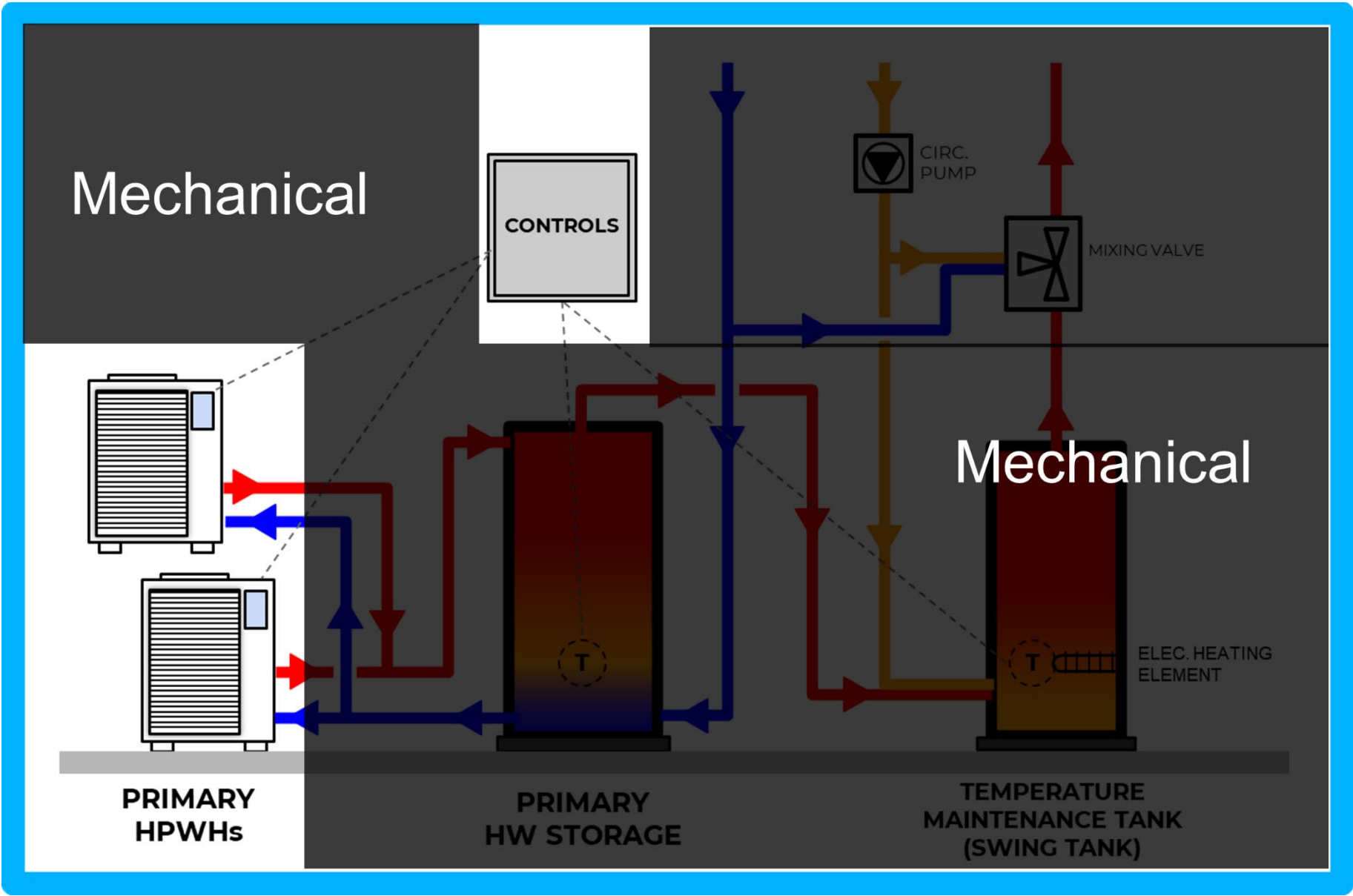

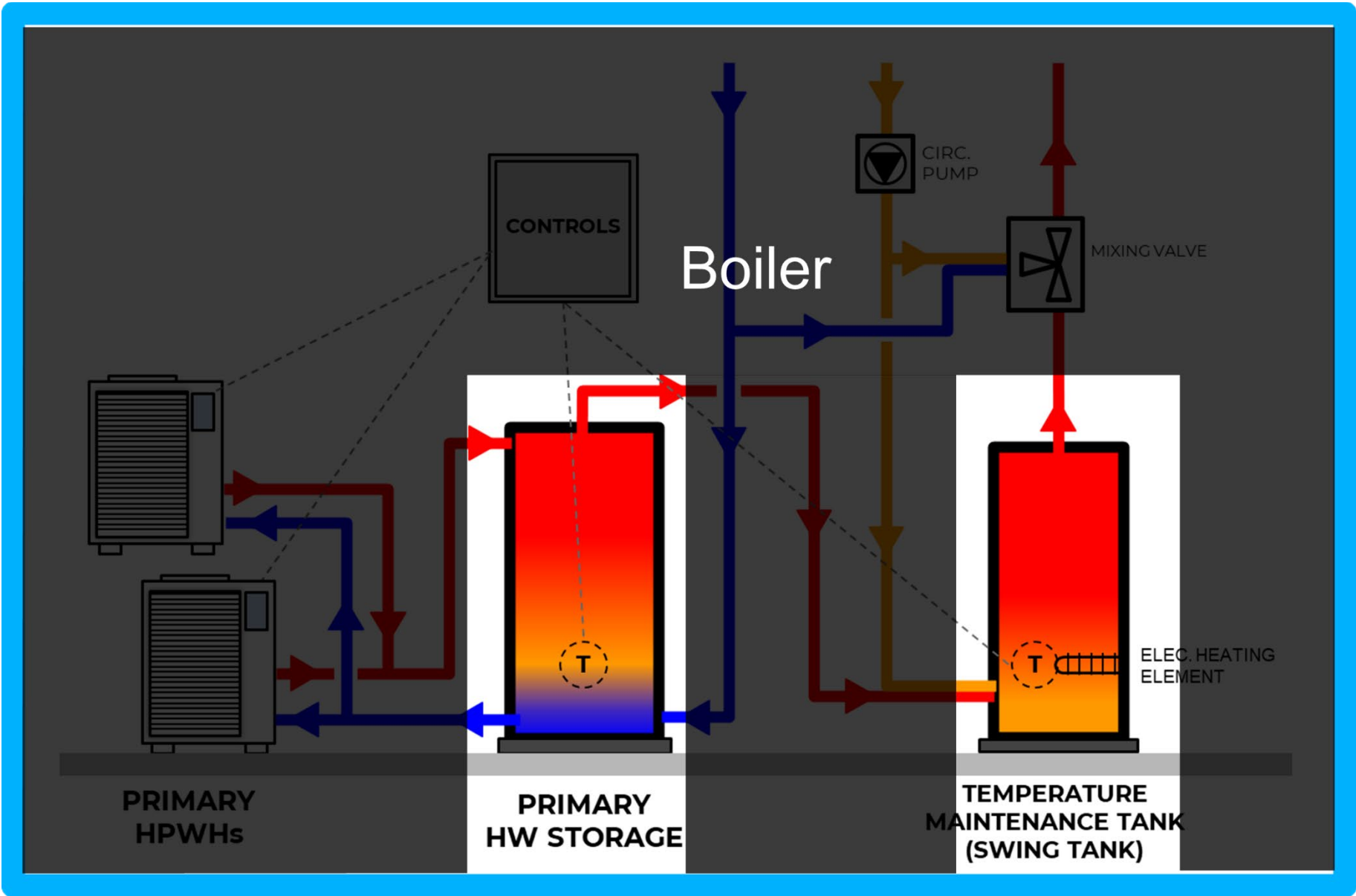

PH-SKC

